

MONTAJ VE KULLANIM KLAVUZU

ASSEMBLY MANUEL

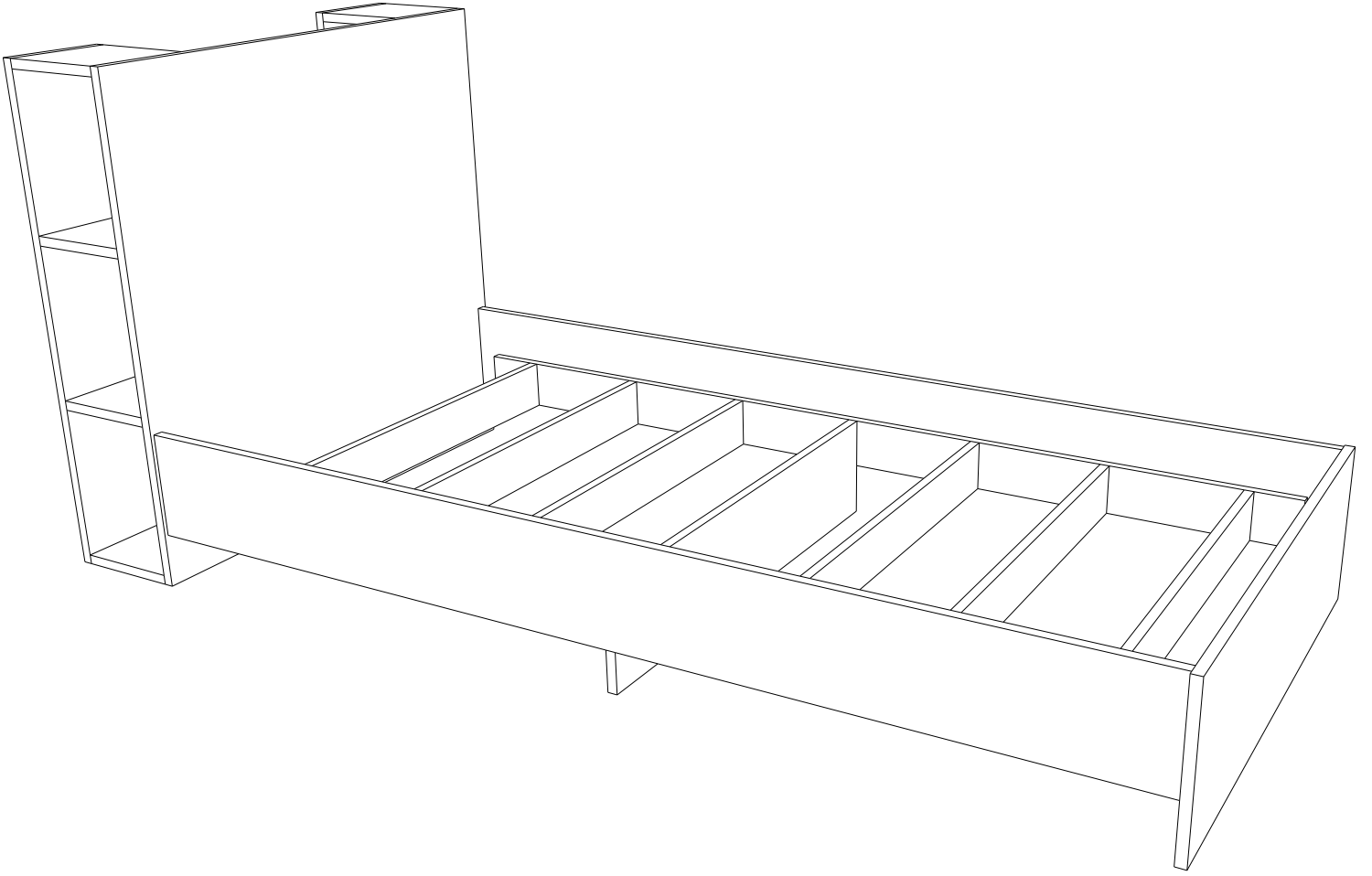

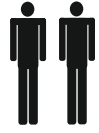

Bu modül iki kişi tarafından kurulmalıdır.
This unit should be assembled by two persons.

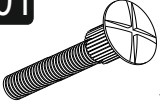

AKSESUAR LİSTESİ / ACCESSORY LIST

Bu modülün kurulumu için gerekli olan araçlar.
The necessary tools (not included)

| | | | | |
|---|---|---|---|--|
| R01 Montebent Vidası  x8 | R02 4x50 YHB Vida  x68 | R03 3,5x18 YHB Vida  X32 | R04 Tapa Ana Renk BÜ KÜ x40 Değişken BÜ KÜ | R05 Karyola Demiri X4 |
|---|---|---|---|--|

PARÇA KODLAMA / GENERAL VIEW

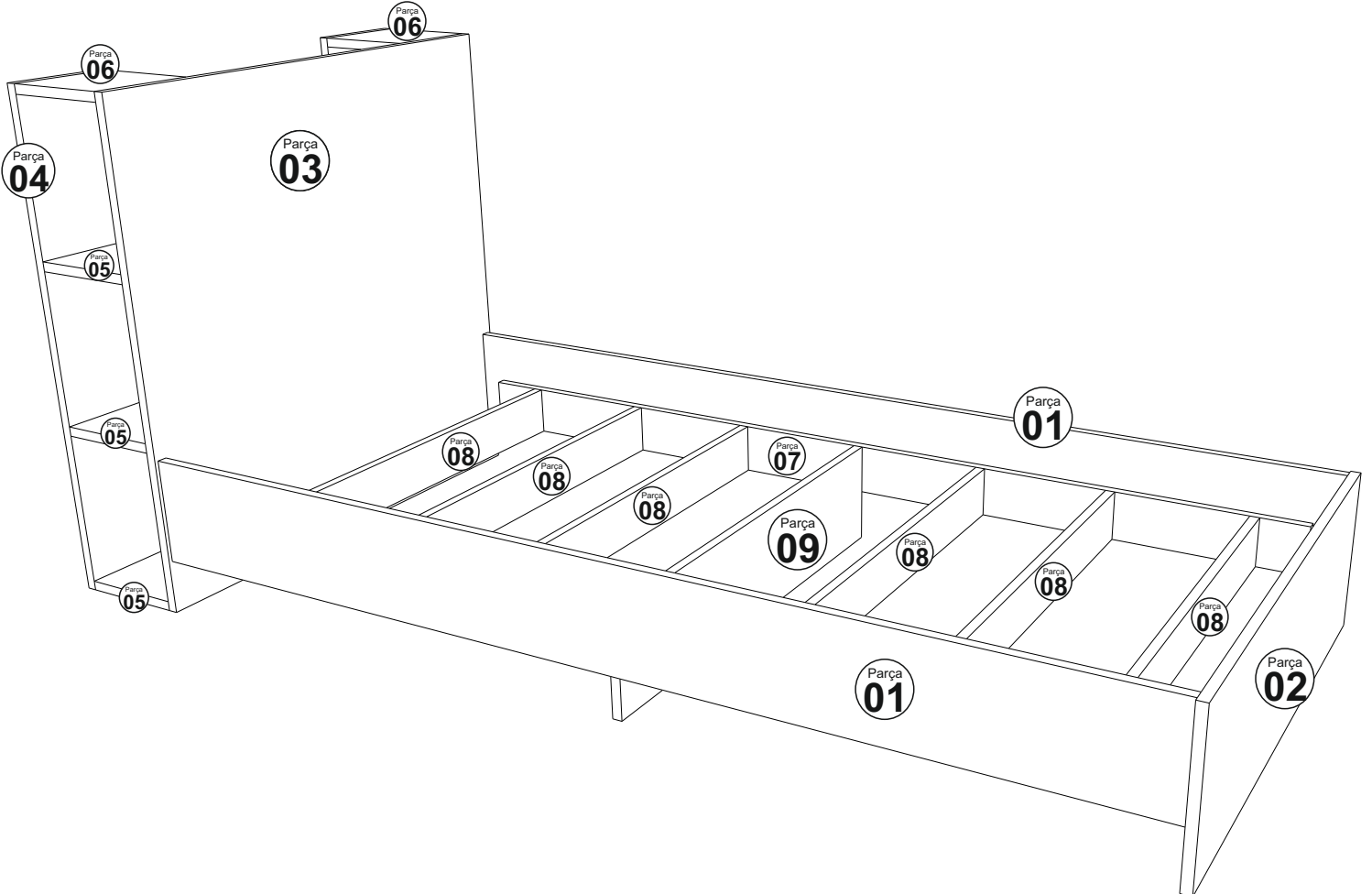

Bu modül iki kiři tarafından kurulmalıdır.
This unit should be assembled by two persons.

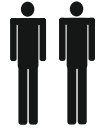

PARA KODLAMA / GENERAL VIEW

