

39822930

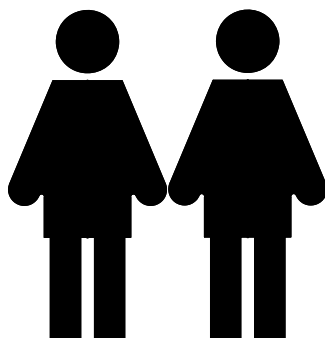
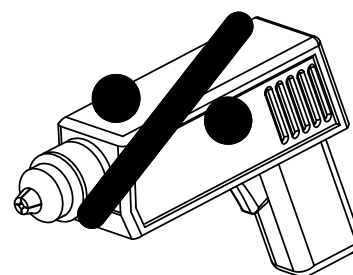
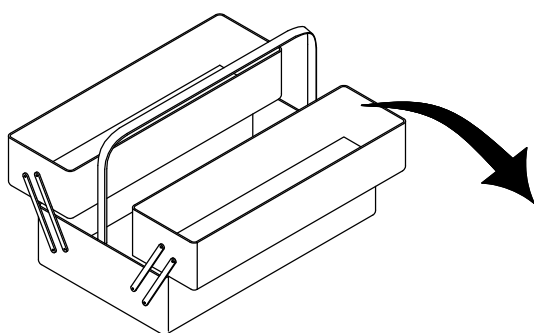
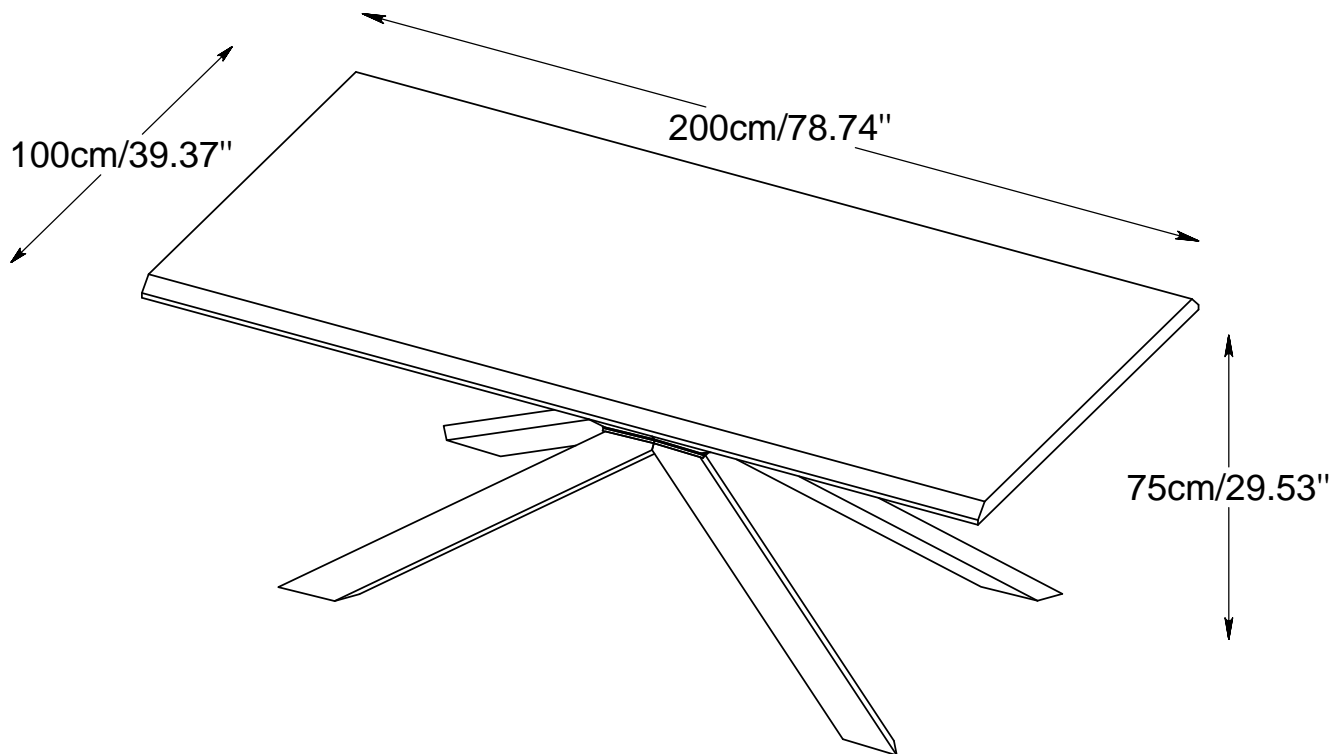

WICHTIG - FÜR SPÄTERE VERWENDUNG  
AUFBEWAHREN - SORGFÄLTIG LESEN

AVIS - Ces instructions doivent être sauvegardées  
Pour utilisation future - Les instructions doivent  
être suivies

IMPORTANTE, conservar estas instrucciones  
para futuro uso. Siga estas instrucciones atentamente

VIGTIGT - Samvejledningen skal opbevares  
i arkiv til senere brug - Skal gennemlæses nøje

NOTICE - These instructions must be saved  
for future use - Instructions must be followed



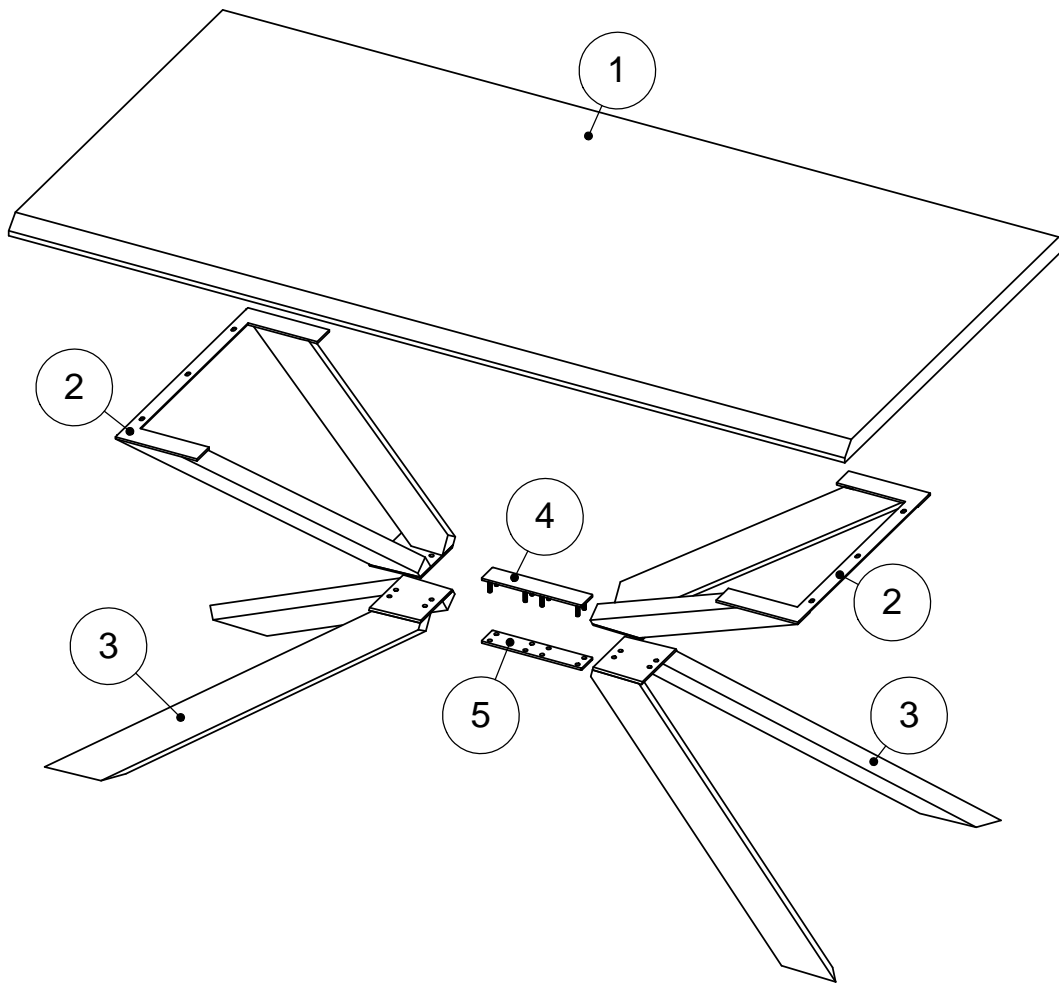

TEILCHECKLISTE  
 LISTE DE CONTROLE  
 LISTADO DE CONTROL  
 TJEKLISTE  
 CHECK LIST

Réf./No.	Réf./Art.	Qty./Stck./Quantité	Size / Maß / Dimension (mm)	Qty./Stck./Quantité	✓
1	326841293	1	2000x1000x42		
2	226812	2	600x610x300		
3	226813	2	750x740x408		
4	226814	1	240x50x35		
5	226815	1	240x50x5		

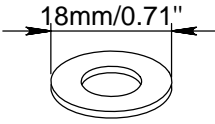

TEILCHECKLISTE - LISTE DE CONTROLE - LISTADO DE CONTROL- TJEKLISTE - CHECK LIST

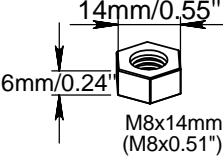
Réf./No.	Réf./Art.	Qty./Stck./Quantité	✓
A	226816	6	
B	226816	14	
C	226816	1	
D	226816	14	
E	226816	8	
E	226816	1	

6 - A	14 - B	1 - C	14 - D	8 - E	1 - F
 <p>M8x25mm (M8x0.98")</p>	 <p>18mm/0.71"</p> <p>M8</p>	 <p>5mm</p>	 <p>M8</p>	 <p>14mm/0.55"</p> <p>6mm/0.24"</p> <p>M8x14mm (M8x0.51")</p>	 <p>70x48mm (2.76x1.89")</p>

Geehrter Kunde.  
Hier haben Sie die Möglichkeit die mitgelieferten  
Schrauben nachzumessen.

Cher Client.  
La règle ci jointe vous permet de mesurer la visserie.

Estimado cliente.  
aquí podrá medir la tornillería adjunta.

Kære kunde.  
Her har De muligheden for at måle medsendte beslag.

Dear Customer.  
Below you have the opportunity to measure the  
Enclosed Hardware.

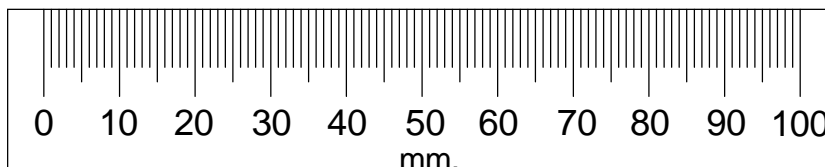

1

18mm/0.71"

C x 1  
A x 6
B x 6
D x 6

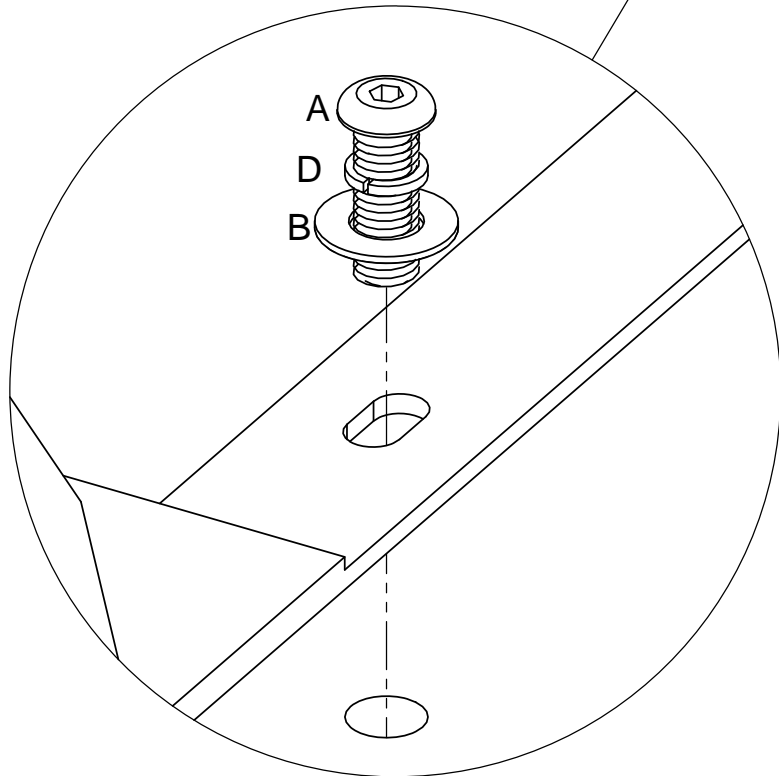
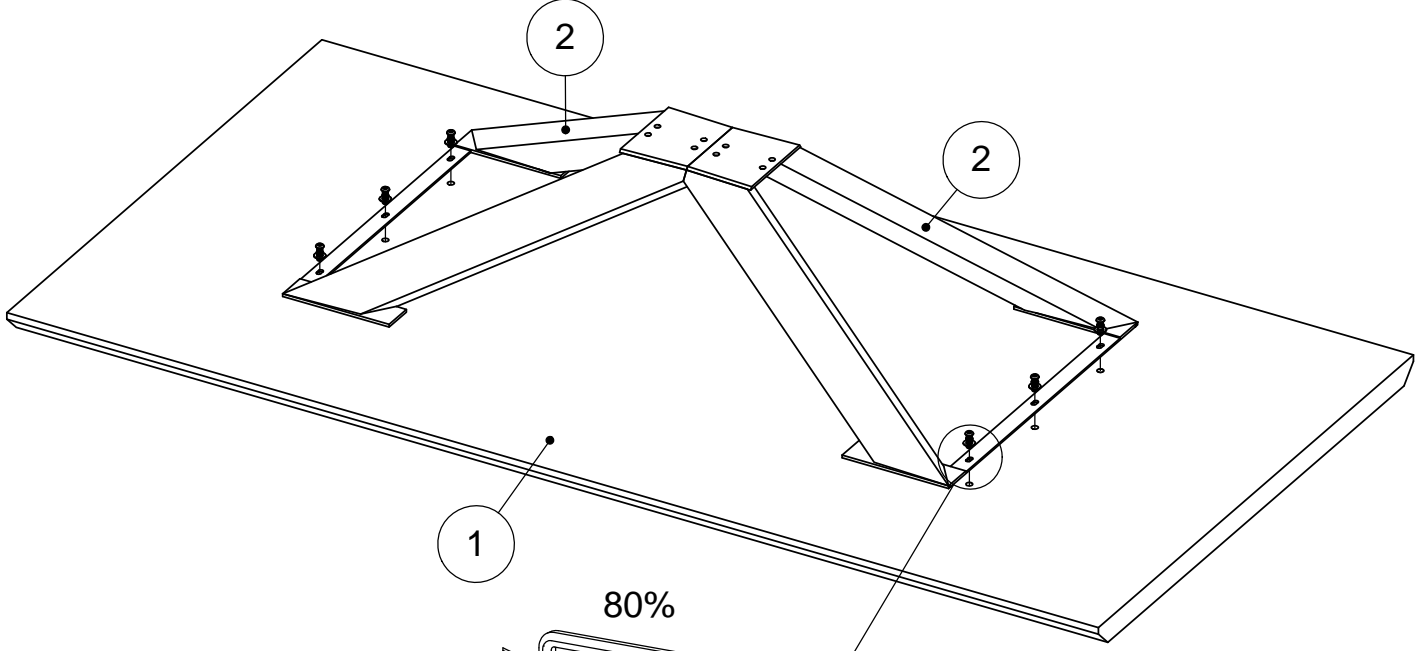

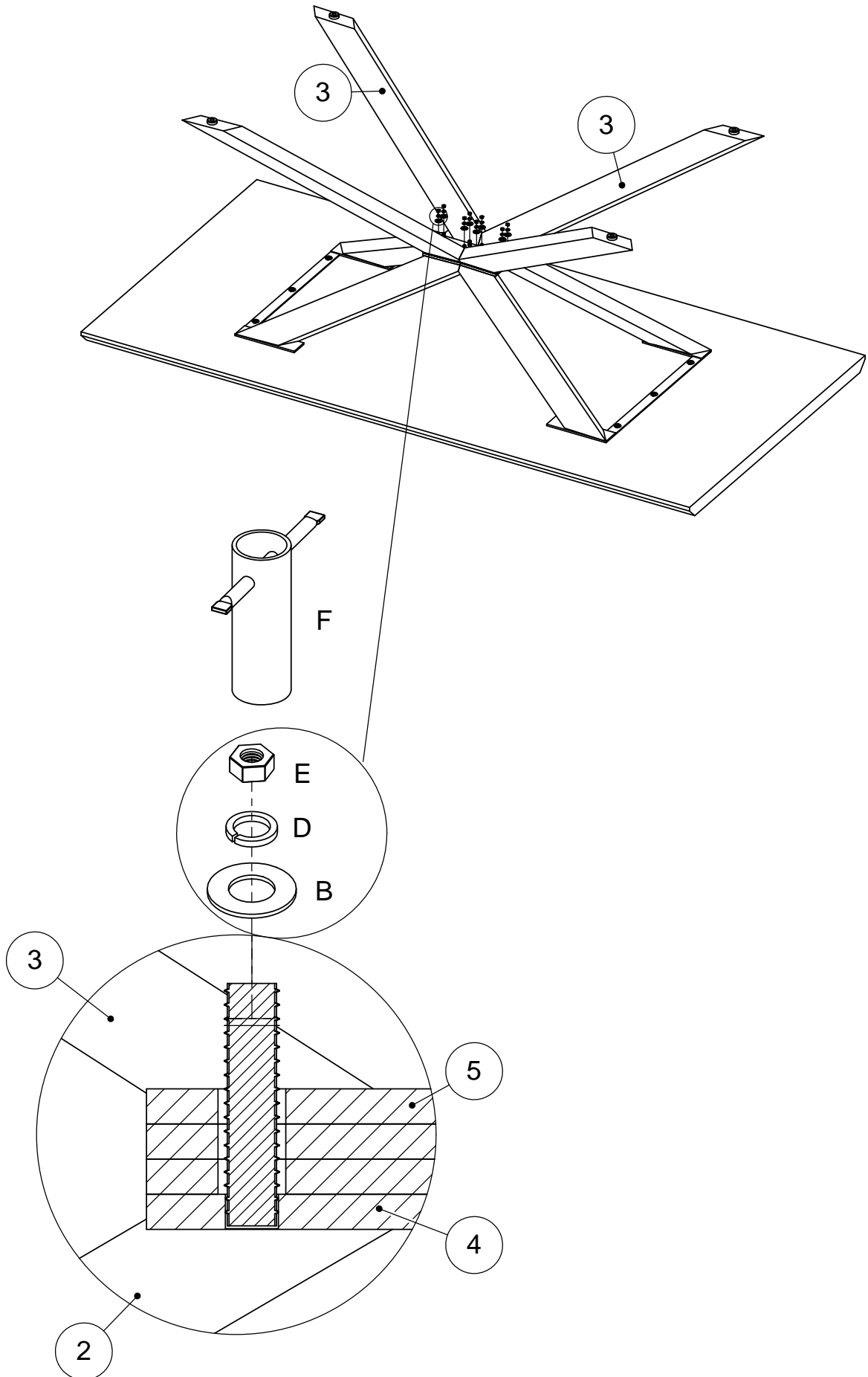
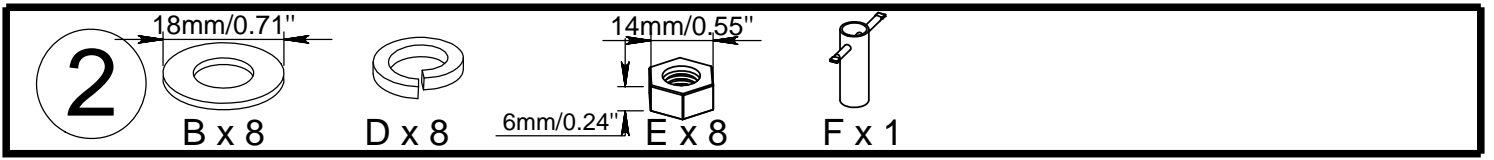

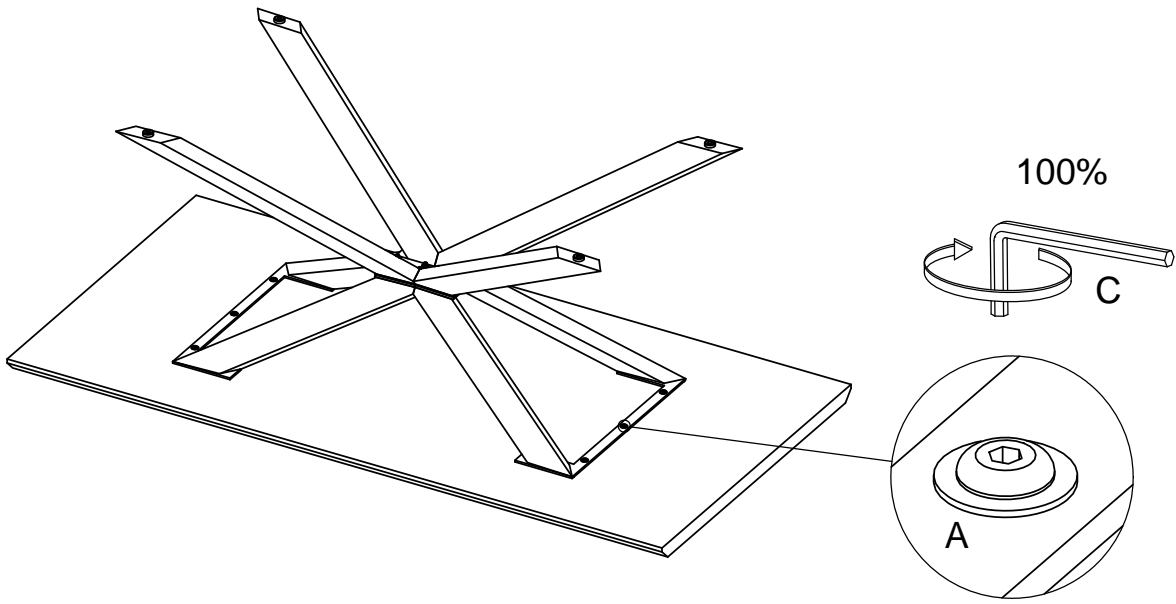

3 C x 1

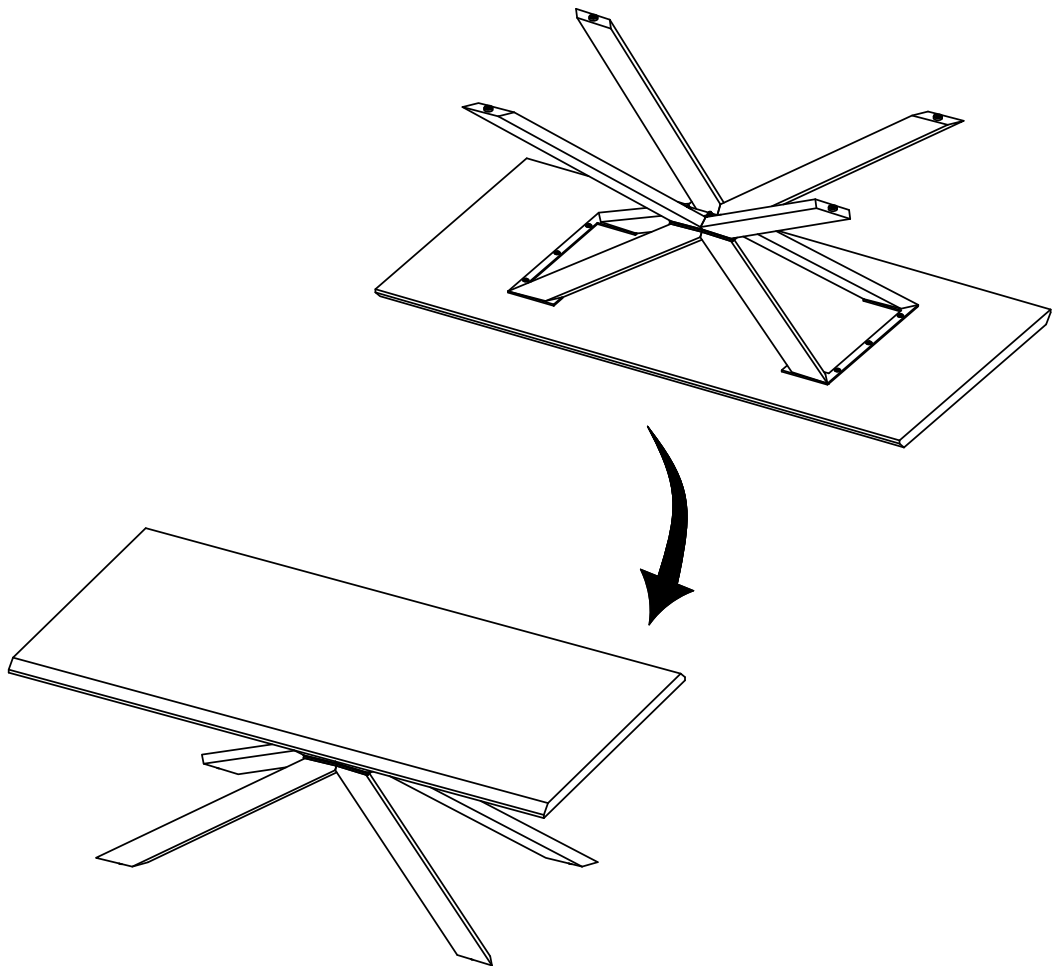

4



5

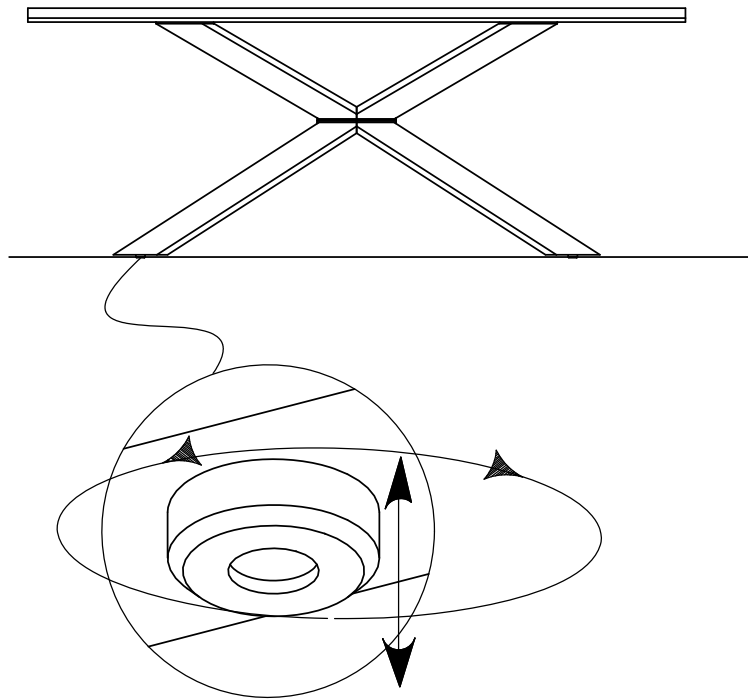

6

