

# Dodatkowa półka - Marsyllia

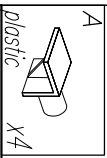

Marsyllia

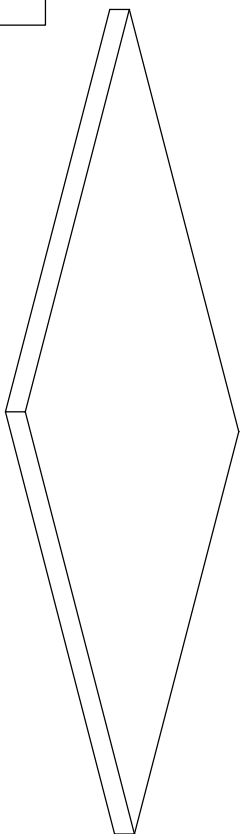
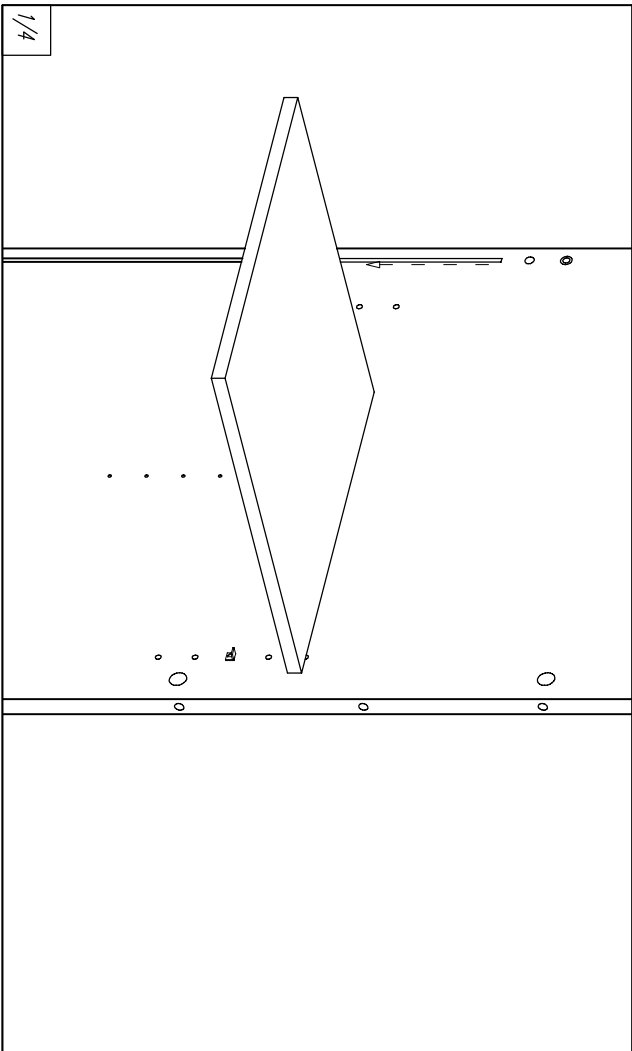
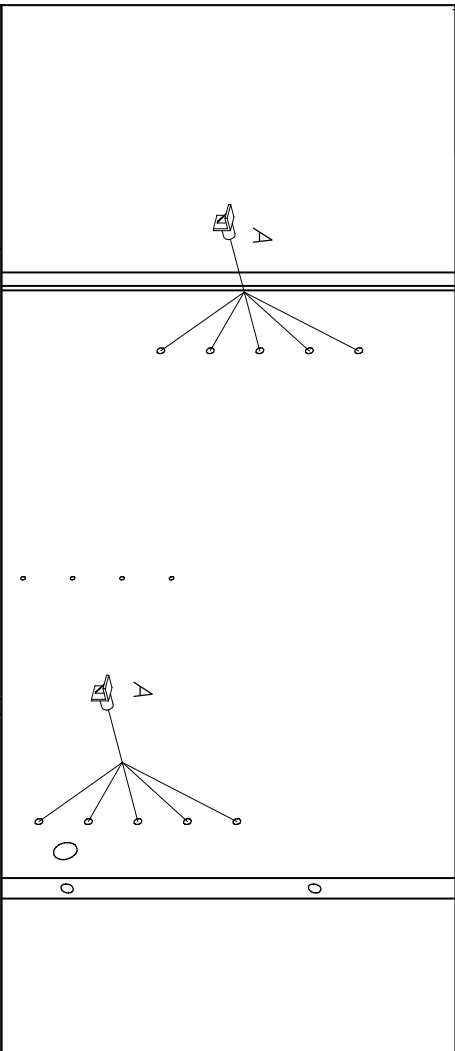

# Dodatkowa półka - Marie, Snap, Swing

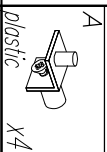
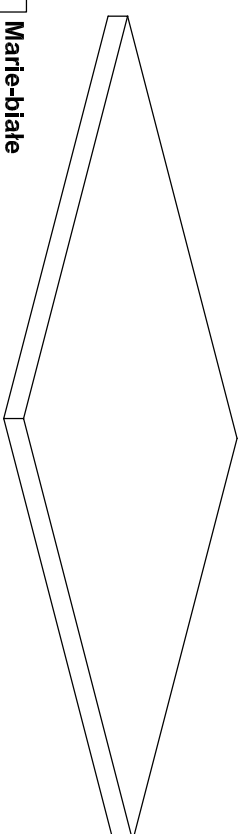

Marie-białe  
Snap-białe  
Swing-białe lub szare

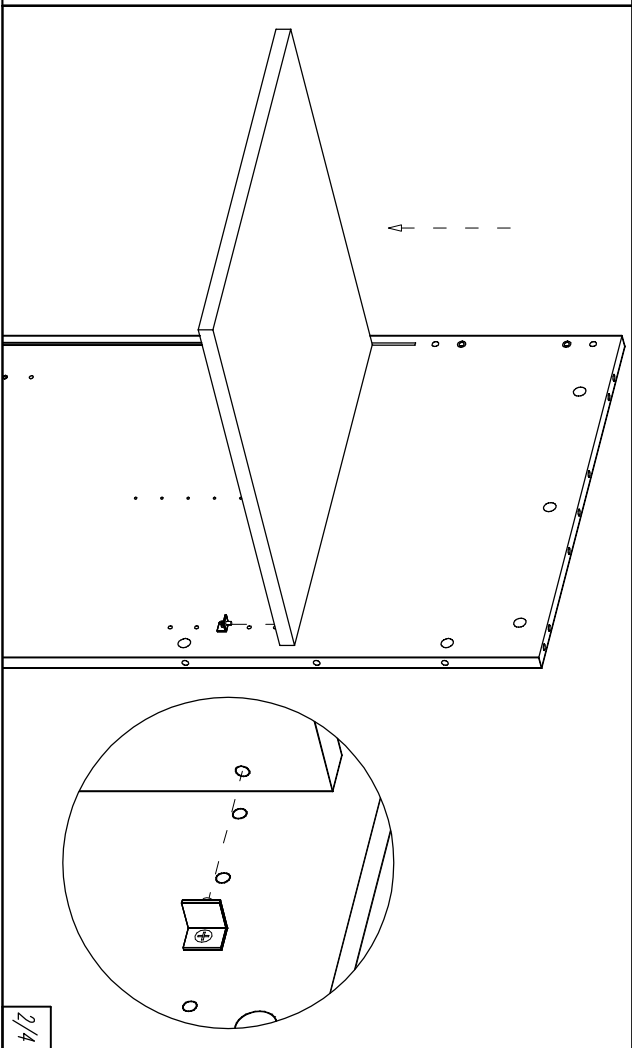
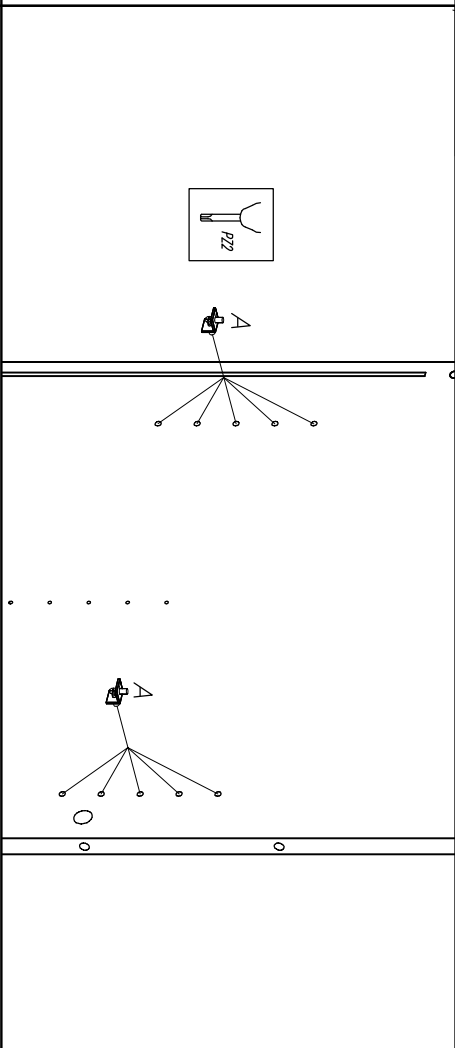

# Dodatkowa półka - Calmo, Cube

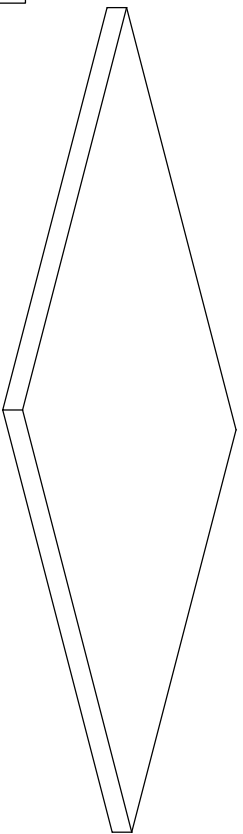

A  
metal  
Calmo  
Cube  
x4

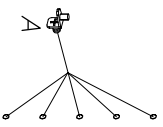
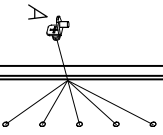

.....

.....

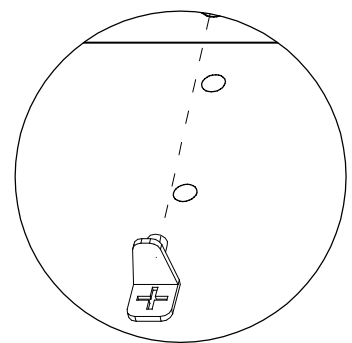
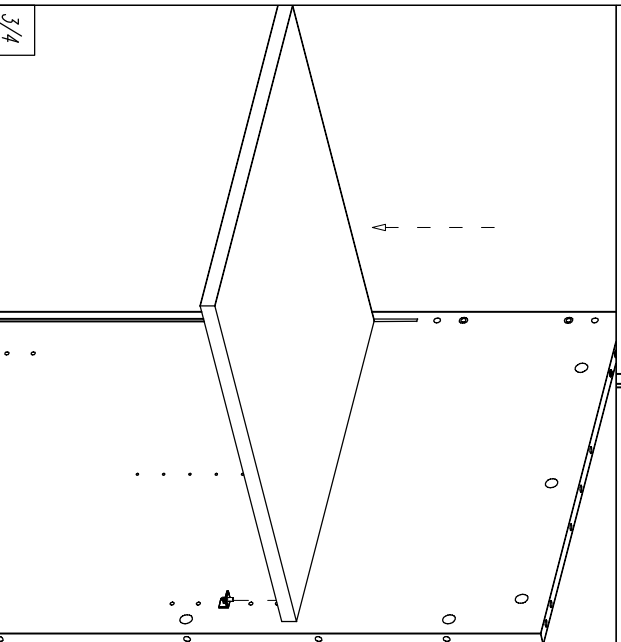

3/4

# Dodatkowa półka - Retro

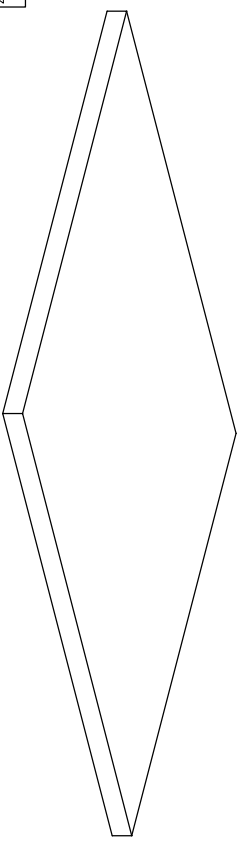

A  
metal  
Retro  
x4



A

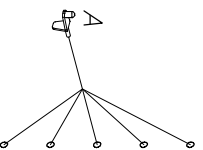
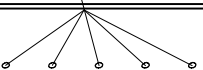

.....

.....

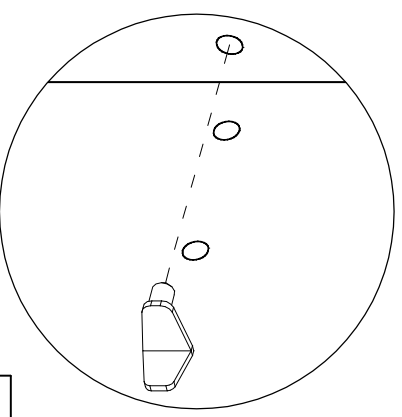
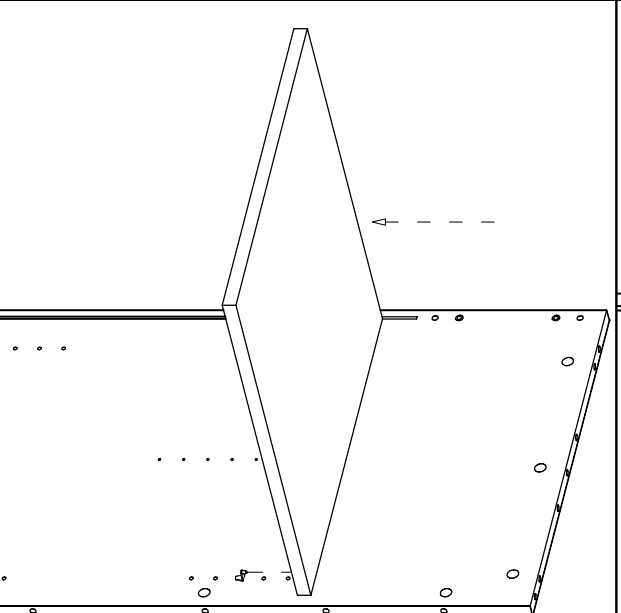

4/4