

# Chicago

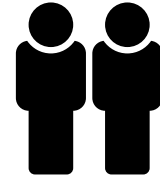

The installation method for a right and left-sided sofa is analogous

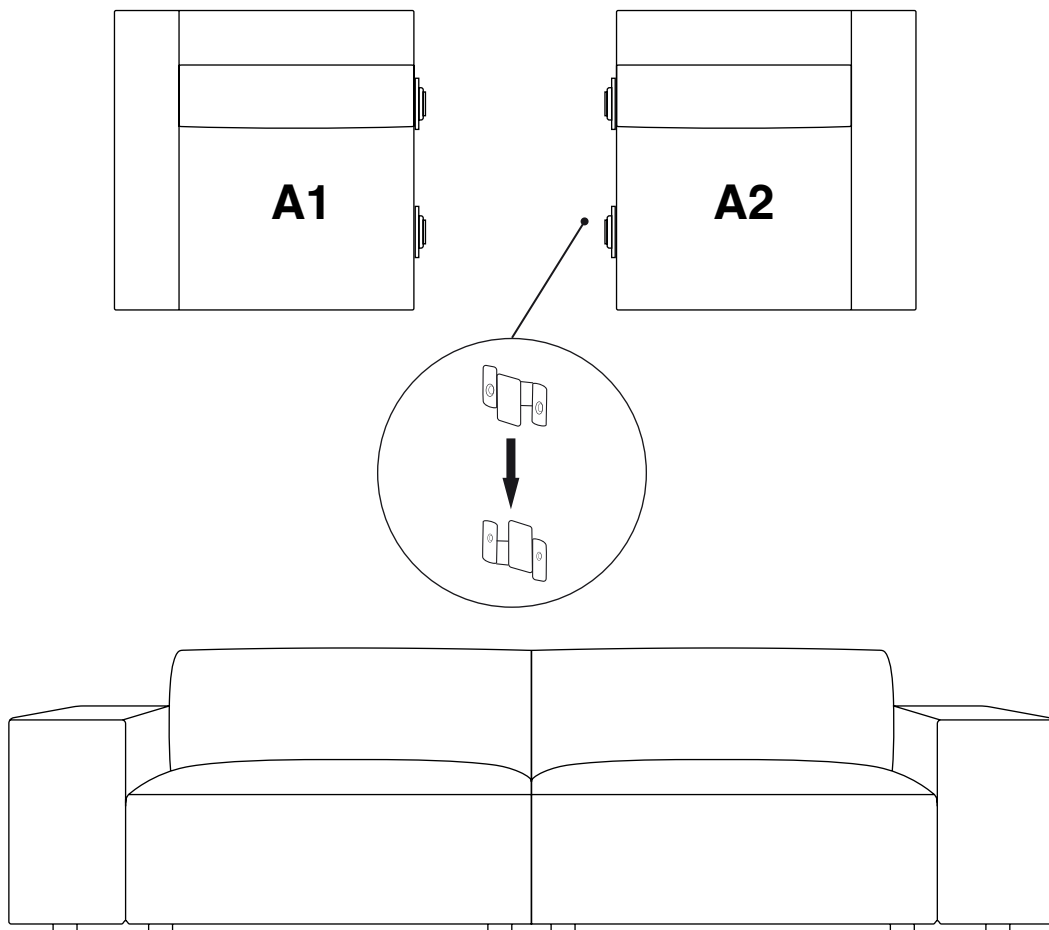

**SHAPE UP ALL PILLOWS AND CUSHIONS!**

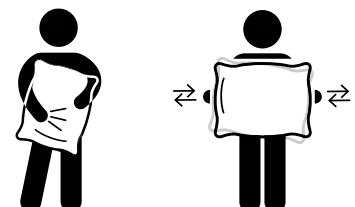

# Chicago

3-seater sofa

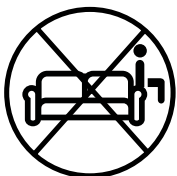
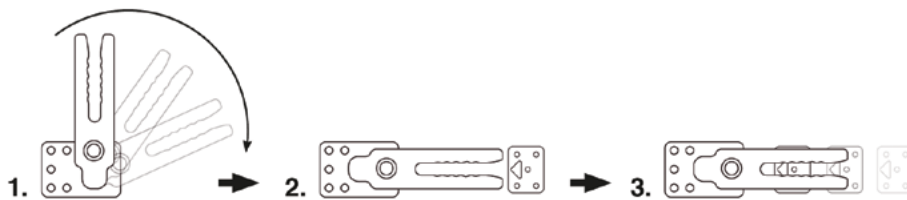
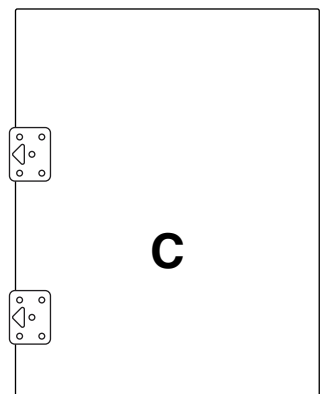
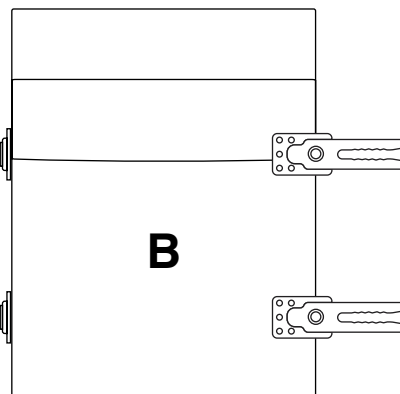
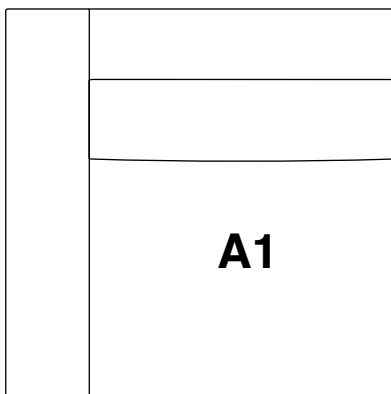
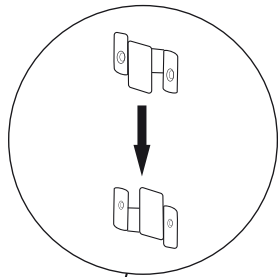
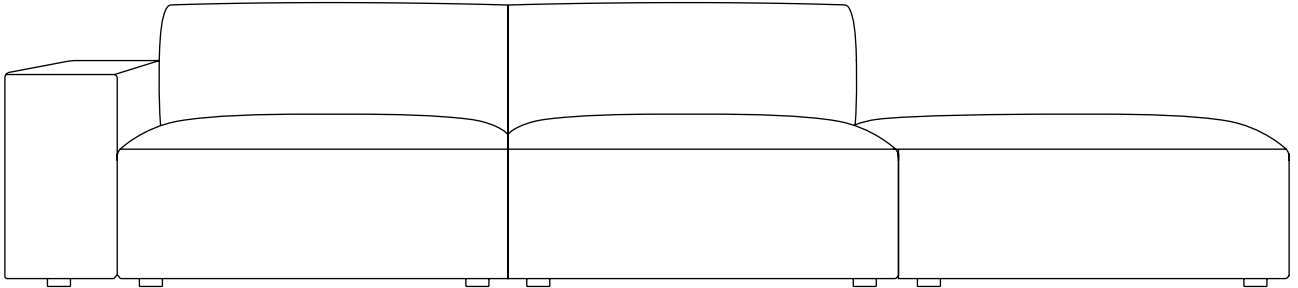
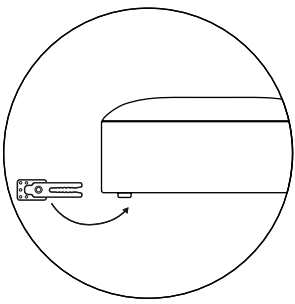

**SHAPE UP ALL PILLOWS AND CUSHIONS!**

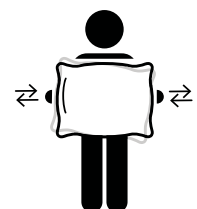

# Chicago

corner sofa

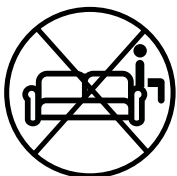
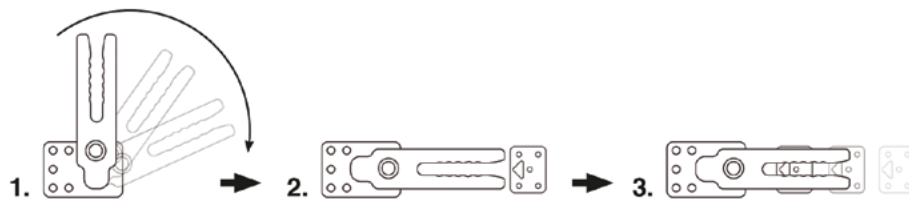
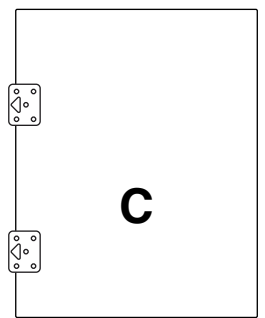
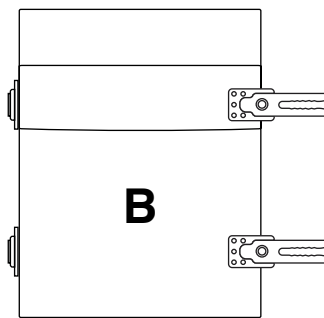
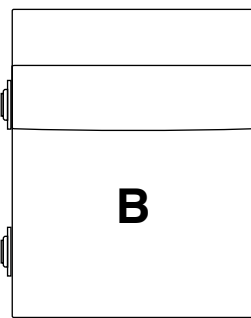
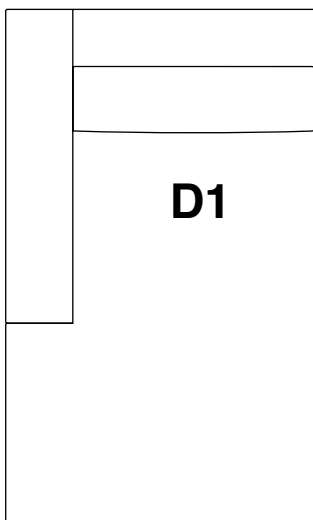
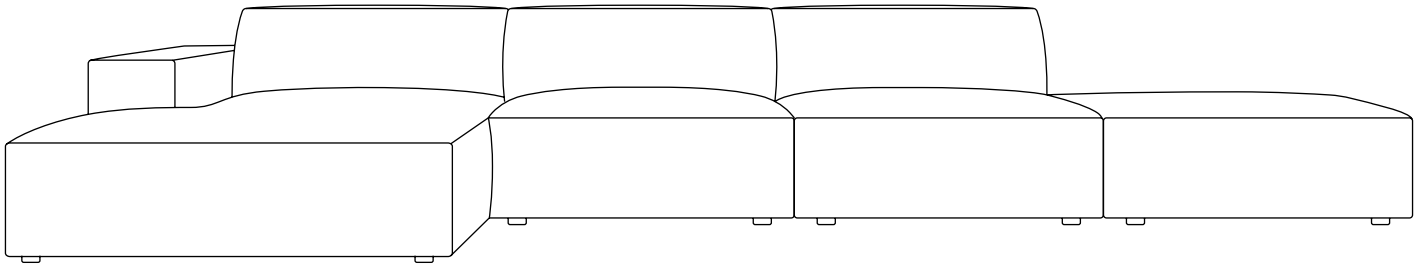
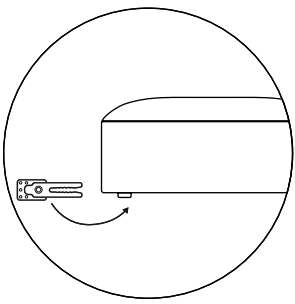

**SHAPE UP ALL PILLOWS AND CUSHIONS!**

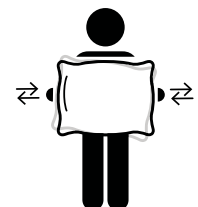

# Chicago

corner sofa

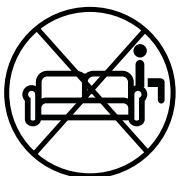
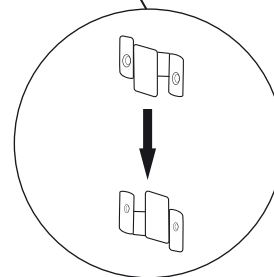
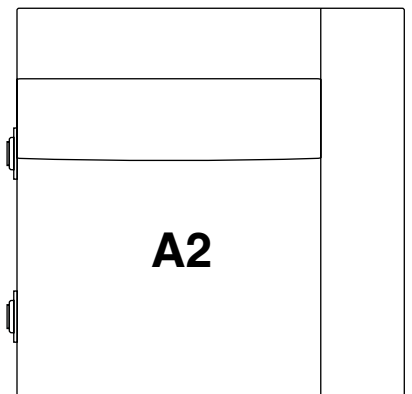
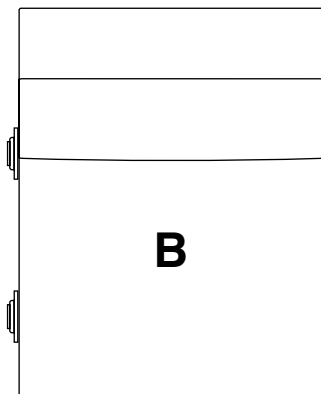
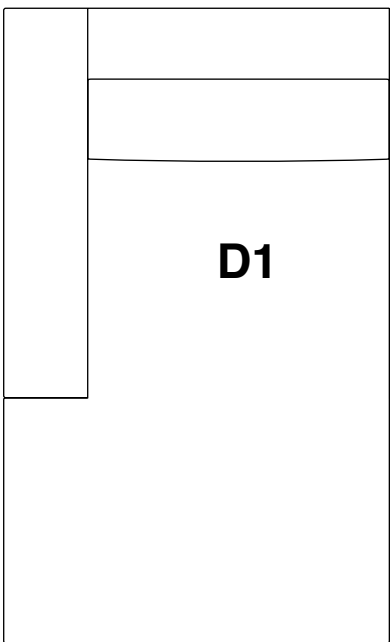
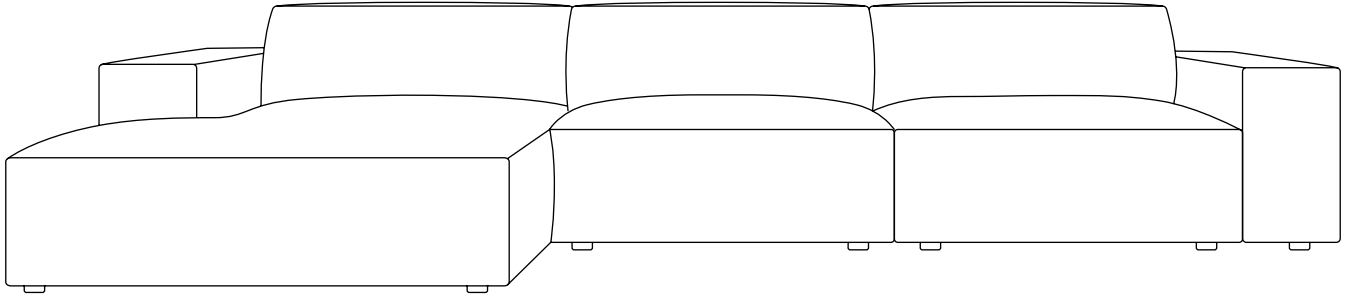
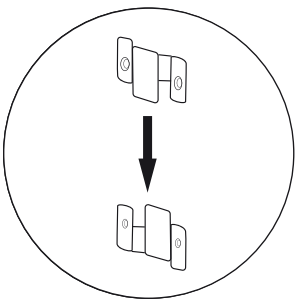

**SHAPE UP ALL PILLOWS AND CUSHIONS!**

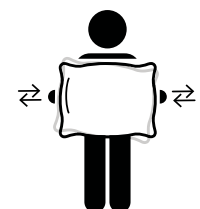

# Chicago

panoramic sofa

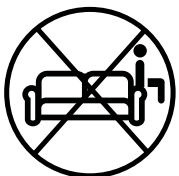
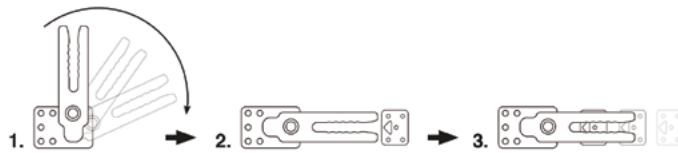
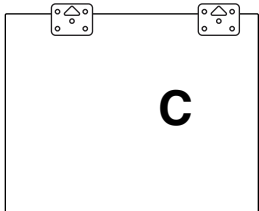
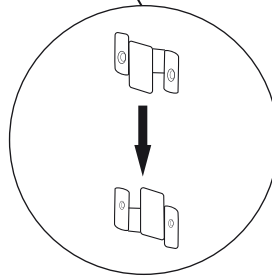
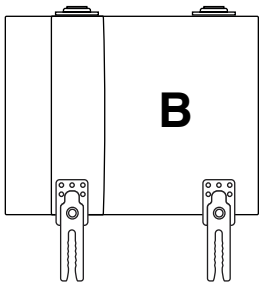
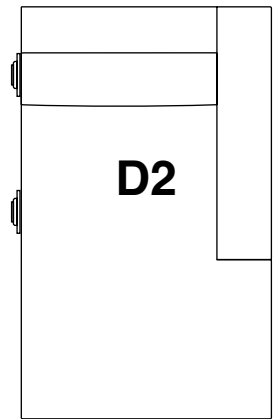
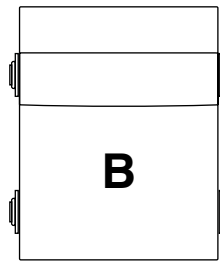
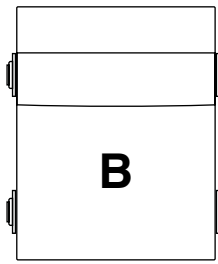
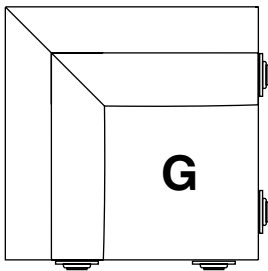
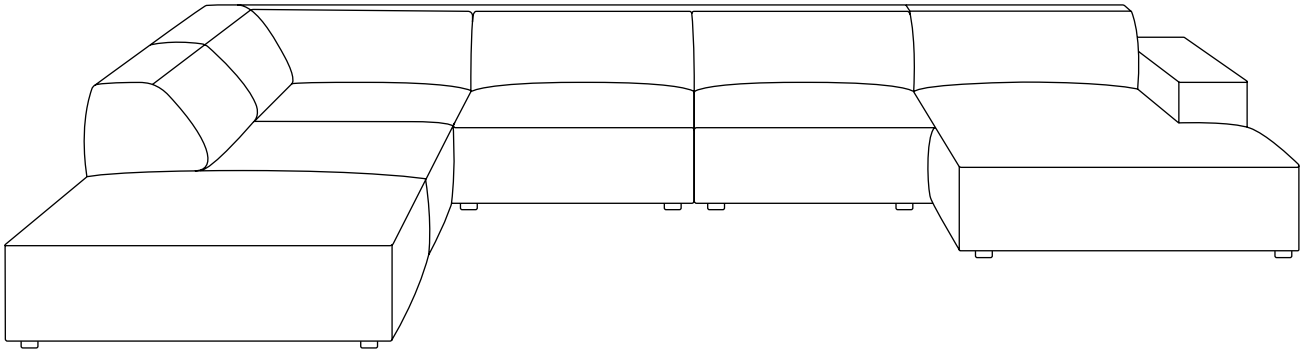
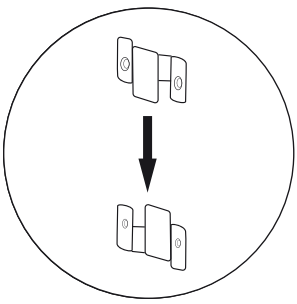

**SHAPE UP ALL PILLOWS AND CUSHIONS!**

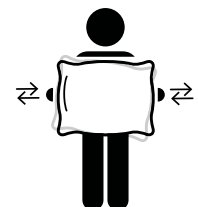

# Chicago

panoramic sofa

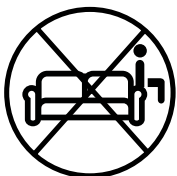
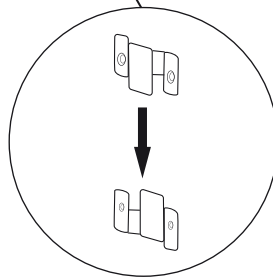
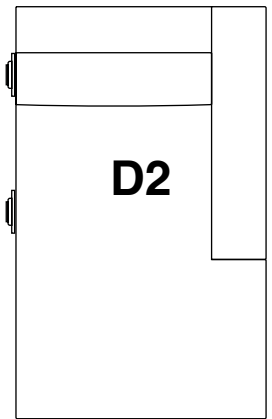
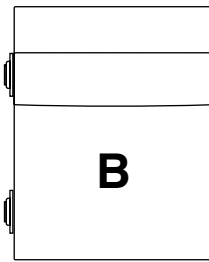
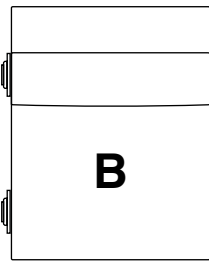
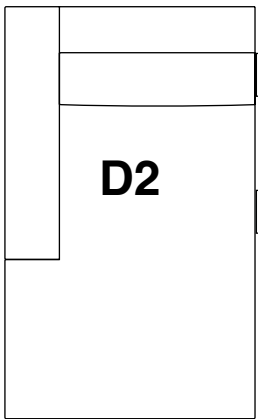
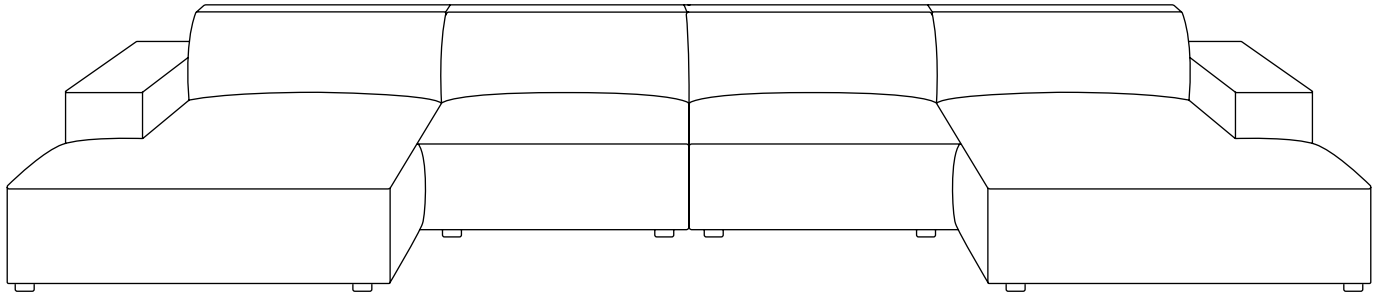
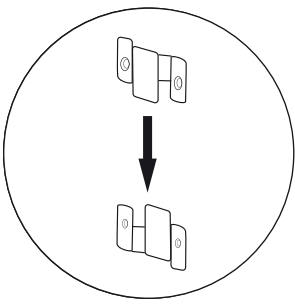

**SHAPE UP ALL PILLOWS AND CUSHIONS!**

